

LF Series
Bidet Faucet
(w/ Pop-up Waste)



Features

- Design Concept is Life and Flex.
- TOTO original cartridge for smooth control
- High corrosion resistance plating
- TOTO aerated water technology, ECOCAP adds air to the water to achieve full water jet with less amount of water usage.

Specifications

Finish: Chrome
Material: Brass
Water Pressure: 0.05Mpa~0.1Mpa

Parts description

- **TRS04301B**
Bidet Faucet (w/ Pop-up Waste)

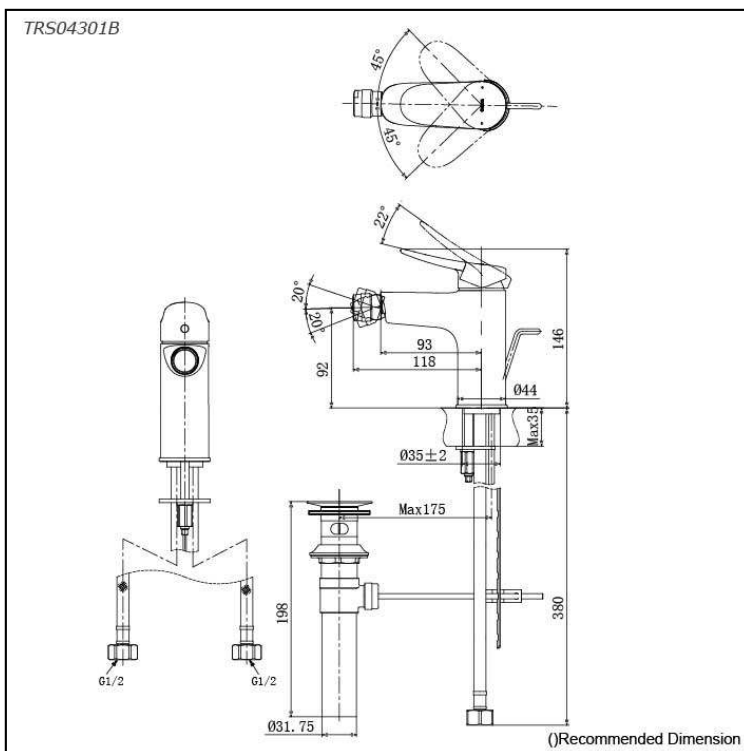

Flow Rate

TRS04301B

