

FG1

A2

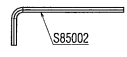
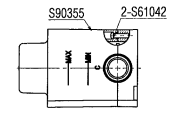
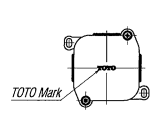
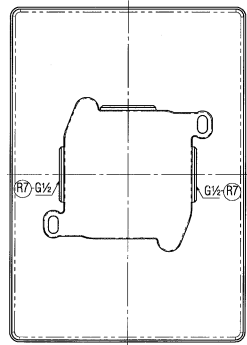
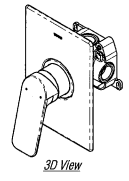
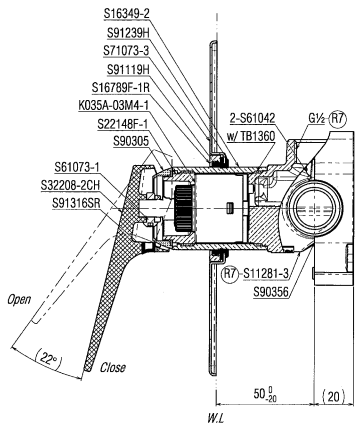
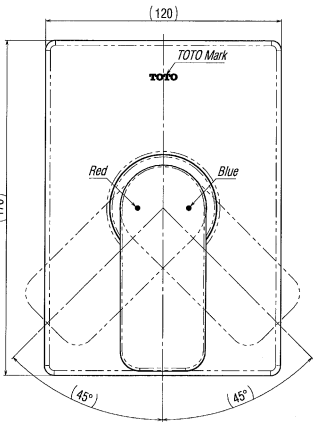

Note :

TX443SRSN	TX443SRSNK1
Flange S71088-1	Flange S71073-3 (Mono)

DATE	02.07.2012	SCALE	1 : 1	Waterlief Malaysia
DESIGNER	[Signature]	CHECKER	[Signature]	APPROVER

REVISION	DATE	DESCRIPTION	REFERENCE	PERSONNEL	APPROVED	NAME
	05.07.2023	S11281 -> S11281-3, Rev -> G1/2	S6A/LP/P/NO/VI/V22	Rusman N.	[Signature]	TX443SRSNK1

Single Lever Shower Mixer
 SURYA TOTO INDONESIA .PT
 (RS) STIS-CMF10-07